

Data Driving Efficient Asset Delivery

Geoff Roberts
Director Customer & Industry
Oracle

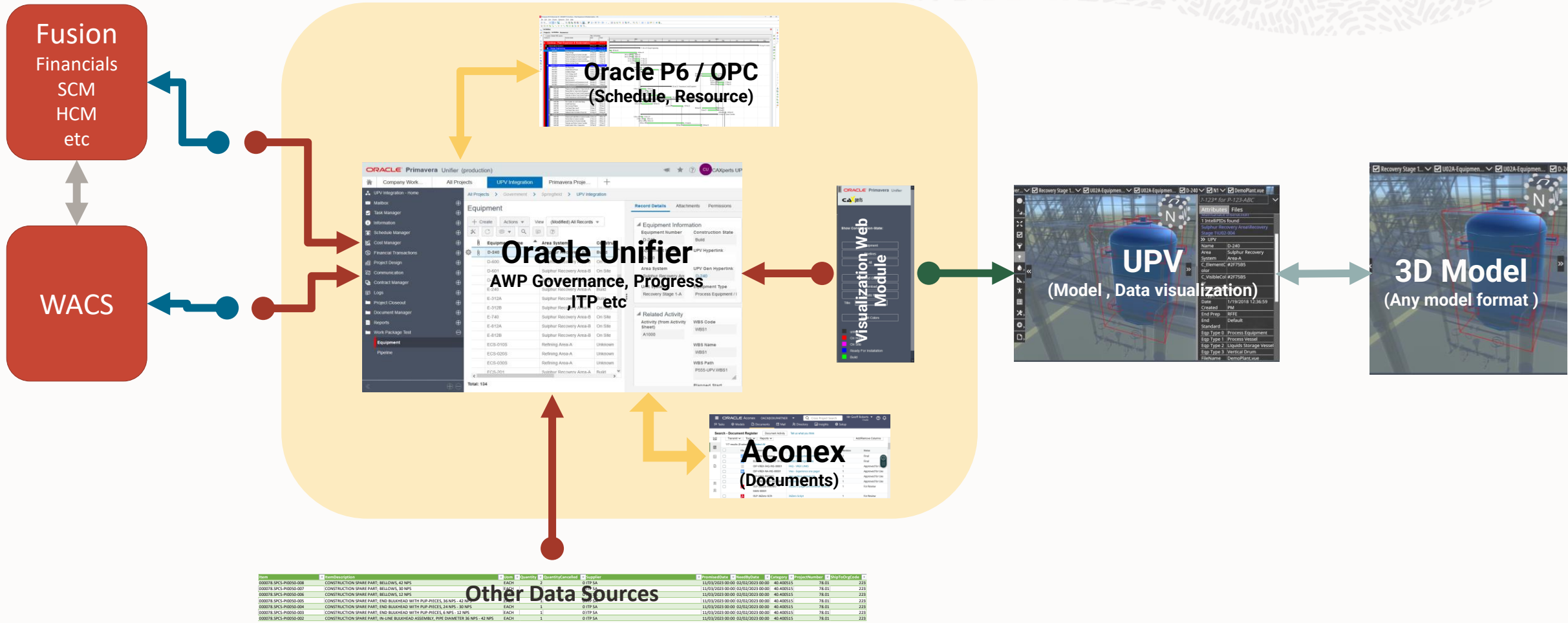

Oracle - Asset Lifecycle data management



The only Infrastructure and Applications Cloud

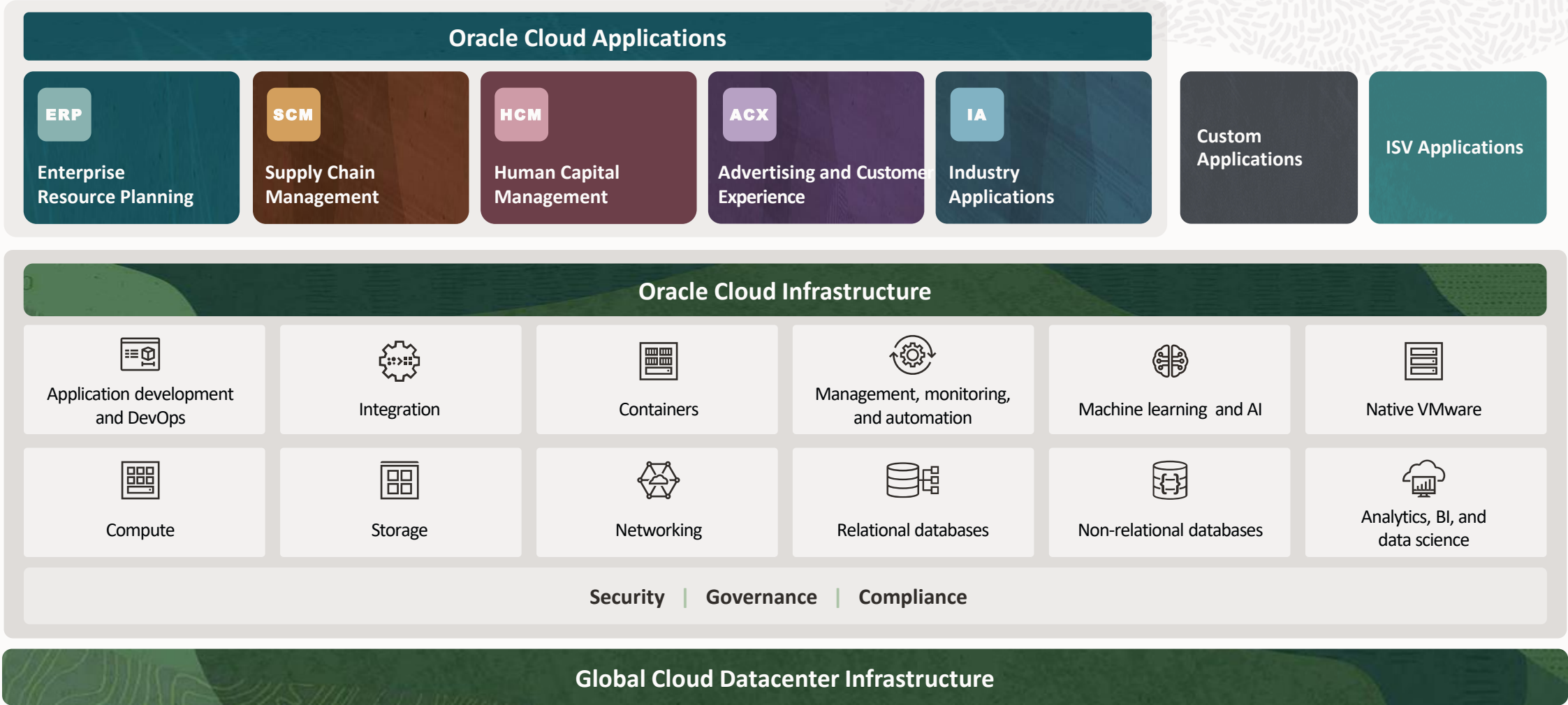

— Connected
 - - - Disconnected

Oracle Cloud Core to Edge

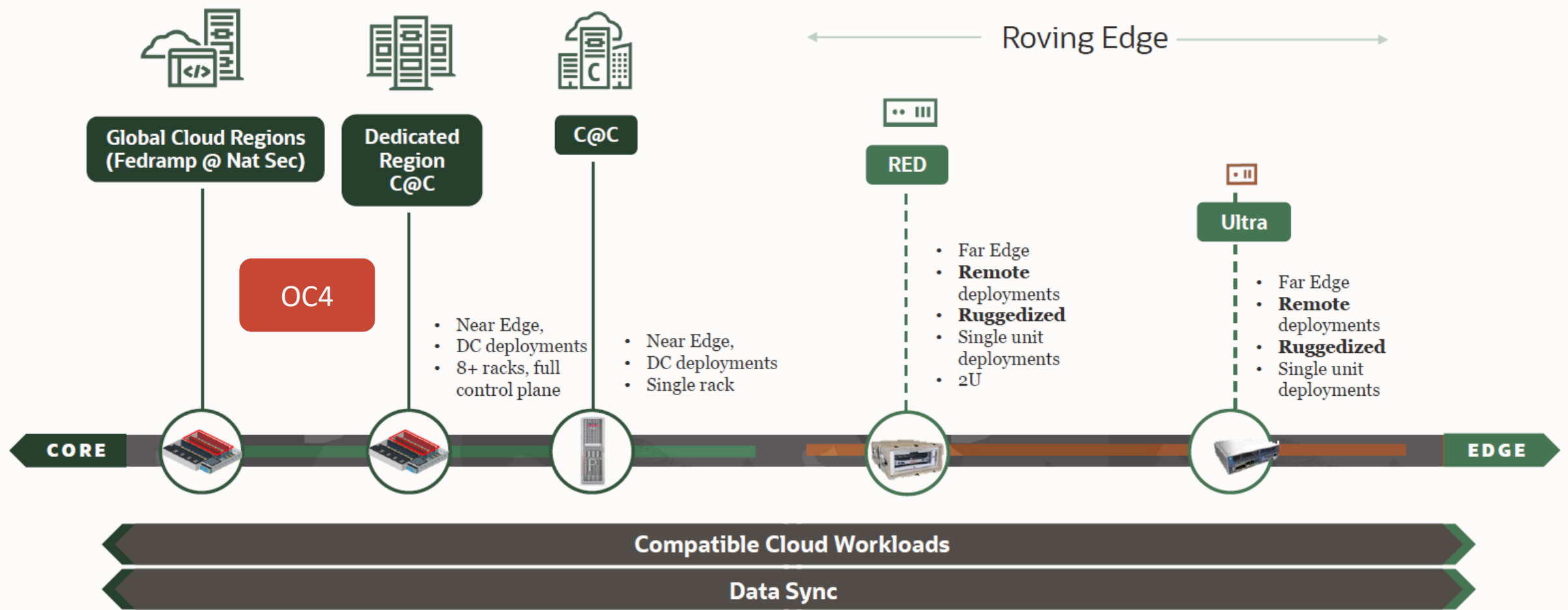

Oracle's Fusion ERP and Smart Construction Platform

Visibility and Control to Orchestrate Corporate Performance and Project Execution

A **complete, modern, cloud ERP** with advanced capabilities, such as AI to automate manual processes, analytics to react to market shifts in real time, and automatic updates to stay current and gain a competitive advantage.

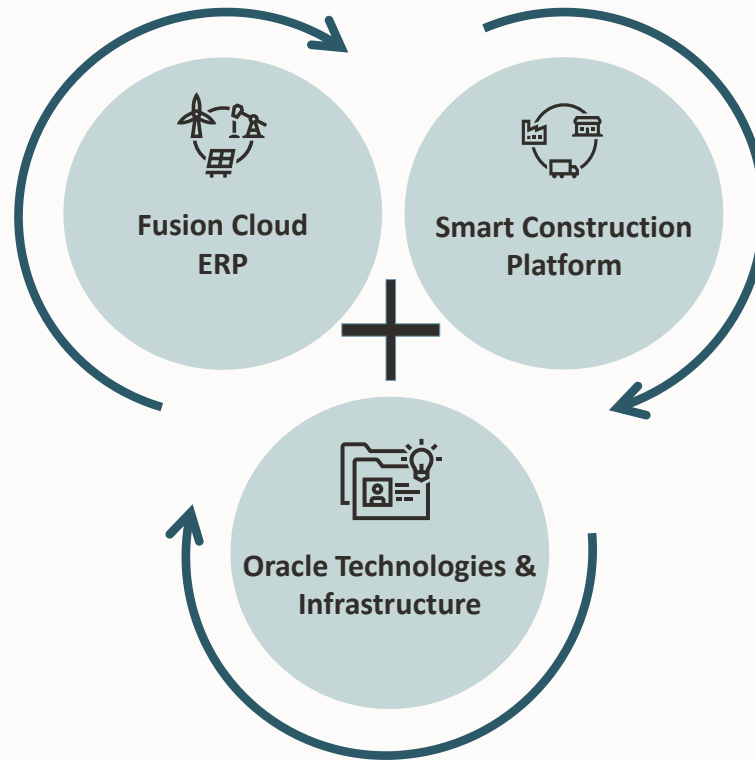

Construction industry-trusted applications with a common data environment and a broad technology ecosystem to help owners and delivery teams work together and continuously improve project outcomes.

Start anywhere, add incrementally, gain exponentially



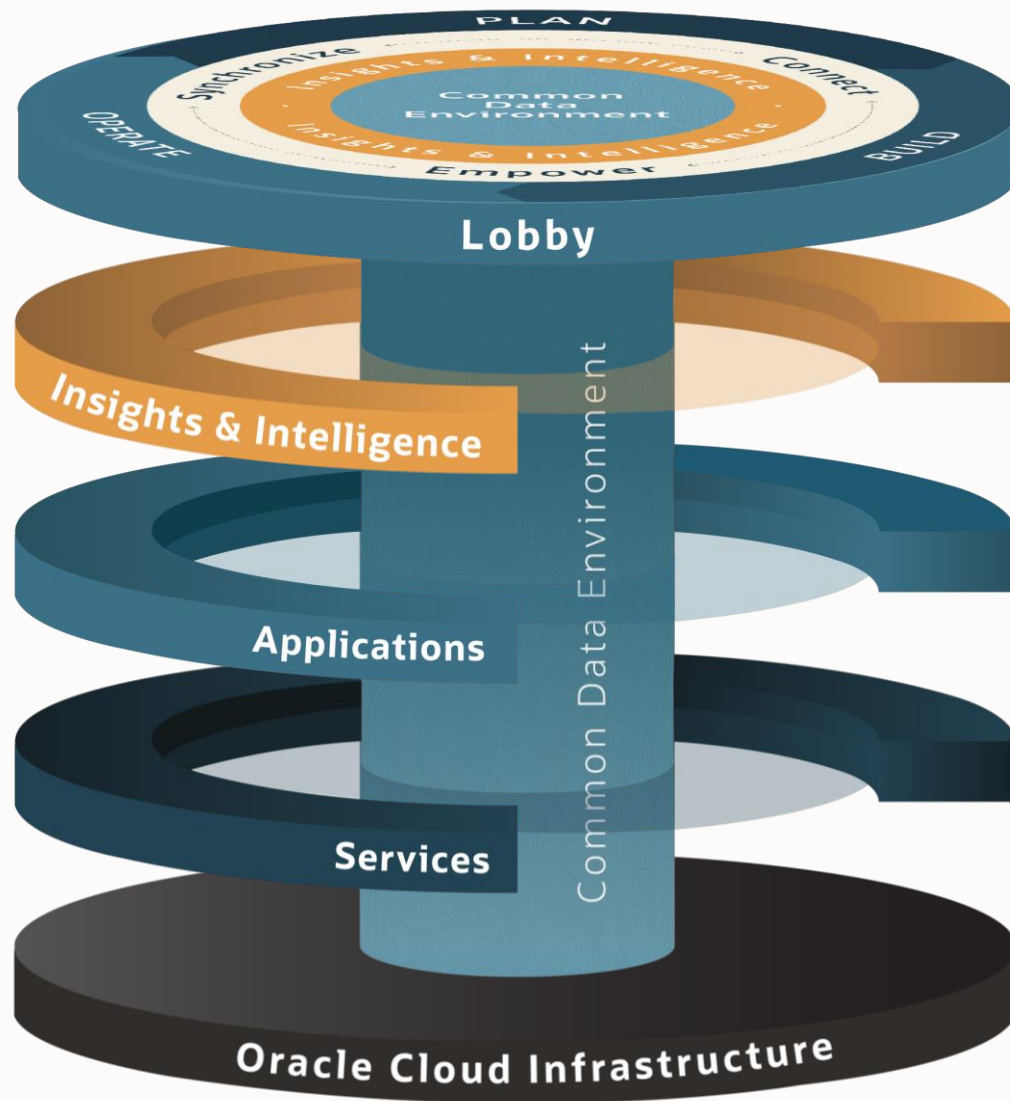

Collaboration Technology Platform:

- Consolidated, unified (Redwood UX) place to enable collaboration across all Stakeholders to leverage for better project execution

Asset and Projects Insights and Intelligence:

- Single source of the truth (CDE)
- Data Visualization (Digital Twin, Analytics)
- Predictive Analytics (AI/ML models)

Asset and Project Lifecycle Application Functionality:

- Portfolio > Project Plan (schedule, scope, risk, team) > Field Collaboration (coordination, progress, issues) > Project Controls (rfi, change) > Project Invoicing/Payments > Project Handover > Asset Operations
- Extended with Partner solution capabilities for turnkey solutions which provide industry best practices

Common Platform Services:

- Lobby – consolidate functionality role-based, including partner capabilities (coming soon)
- App Switcher – seamless user experience across functionality
- Project Reference – improved data quality via single source of truth
- Oracle Technology – leverage the power of Oracle across Security, Database, Middleware, Integration, IoT, Analytics/AI, much more

Oracle Cloud Infrastructure:

- Native cloud provisioning across Oracle and increasingly Partners
- Compute resources – scale and elasticity and performance
- Embedded Security from App to Data to Cloud
- Government high compliance certified



The Oracle Smart Construction Platform opens up this opportunity

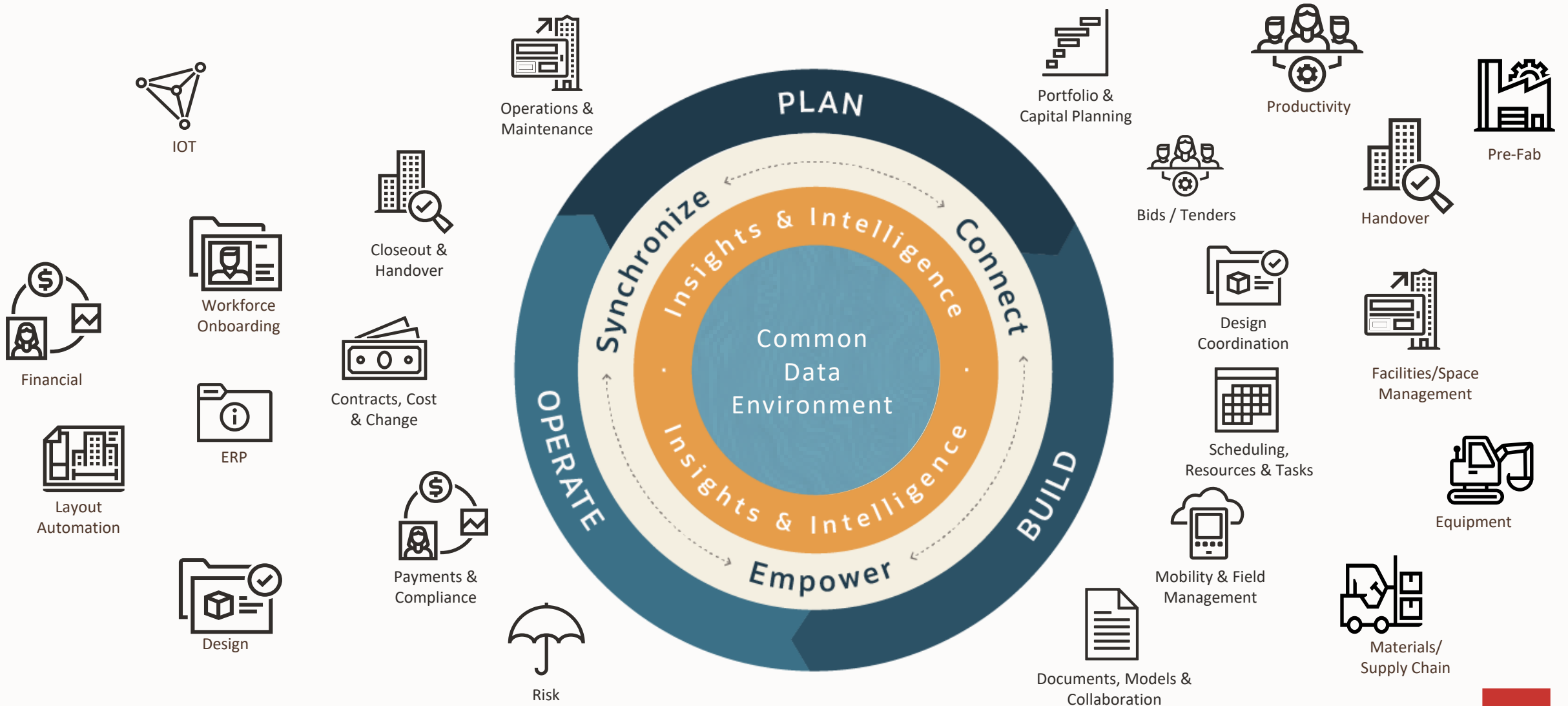

Oracle Smart Construction Platform Hi-Level Architecture

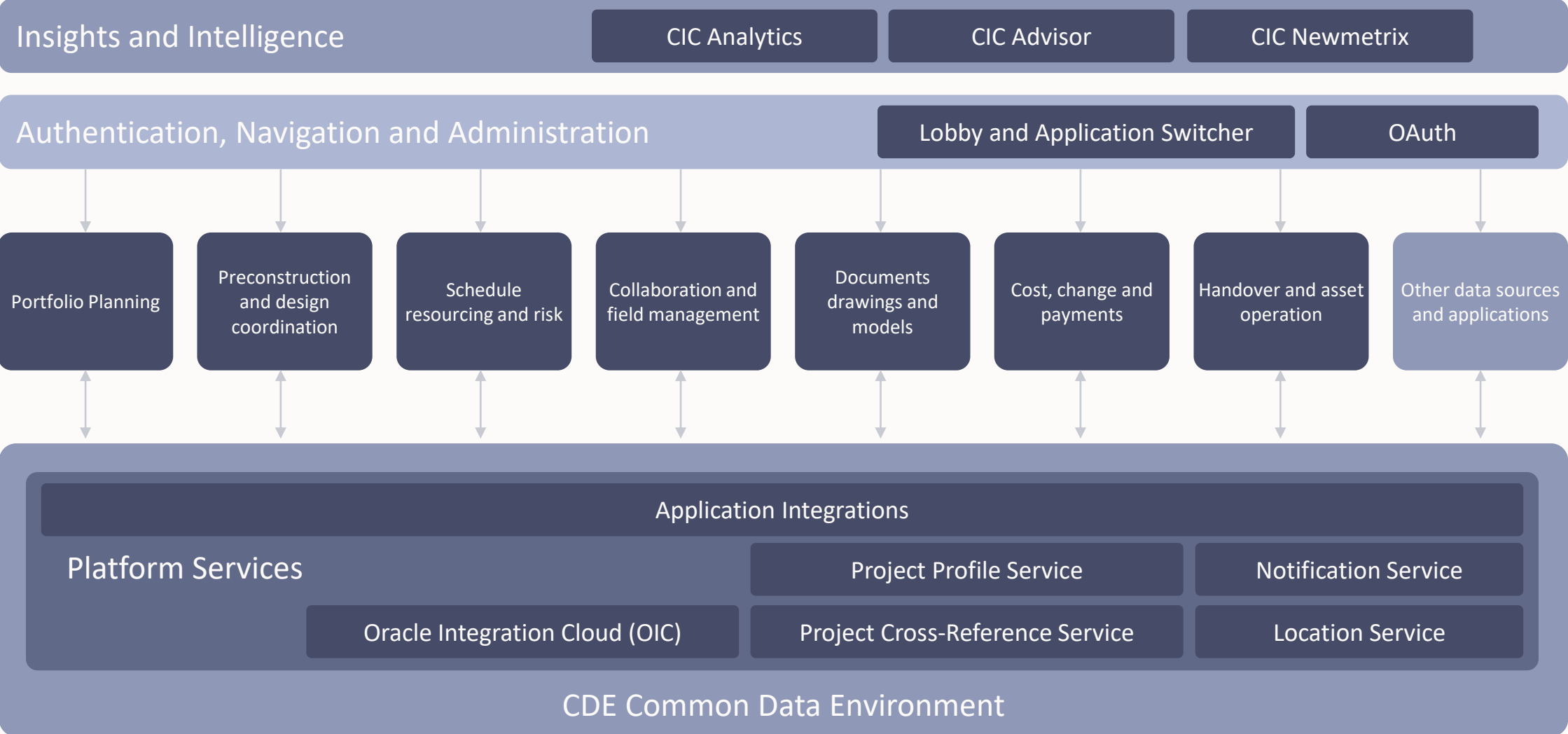

Applications

Select the application to open

- Aconex**
US & Latin America (US1)
- Construction Intelligence Cloud Advisor**
- Primavera Cloud**
Majestic Builder AU
- Primavera Unifier**
- Textura Payment Management**
United States
- Reconstruct**
- Assignar**
- Evercam**
- Faro**

4 CIC Advisor 1

Last updated on Jun 14, 12:43 PM

<p>Active Majestic Builders</p> <p>Ground Tower</p> <p>2 applications Australia/NZ patrick.oleary@majes...</p> <p>2</p> <p>3 linked projects</p>	<p>Active Majestic Builders</p> <p>Sky Phase 2</p> <p>Aconex Australia/NZ poleary</p> <p>A</p> <p>☆ [] ...</p>	<p>Active Majestic Builders</p> <p>Redwood Shores Apartments</p> <p>3 applications Australia/NZ patrick.oleary@majes...</p> <p>3</p> <p>3 linked projects</p>	<p>Active Majestic Builders</p> <p>Breeze Towers</p> <p>Aconex Australia/NZ poleary</p> <p>A</p> <p>2 linked projects</p>
<p>Active Majestic Builders</p> <p>Whistley Field</p> <p>Textura Payment Man... Kingdom of Saudia A... patrick.oleary@majes...</p> <p>T</p> <p>☆ [] ...</p>	<p>Active Majestic Builders</p> <p>b1074 Chigley Tower</p> <p>Primavera Cloud Australia/NZ patrick.oleary@majes...</p> <p>PC</p> <p>☆ [] ...</p>	<p>Active Majestic Builders</p> <p>Chigley Tower</p> <p>Aconex Australia/NZ poleary</p> <p>A</p> <p>☆ [] ...</p>	<p>Active Majestic Builders</p> <p>Camberwick Green Shopping Centre</p> <p>Aconex Australia/NZ poleary</p> <p>A</p> <p>☆ [] ...</p>
<p>Active Majestic Builders</p> <p>Languedoc Shipping Distribution Centre</p> <p>2 applications Australia/NZ patrick.oleary@majes...</p> <p>4</p>	<p>Active Majestic Builders</p> <p>Hampton Shopping Centre</p> <p>Aconex Australia/NZ poleary</p> <p>A</p>		



Unifier (A data platform) – Industry accelerators

Available
Future

EA
SKU/Partner

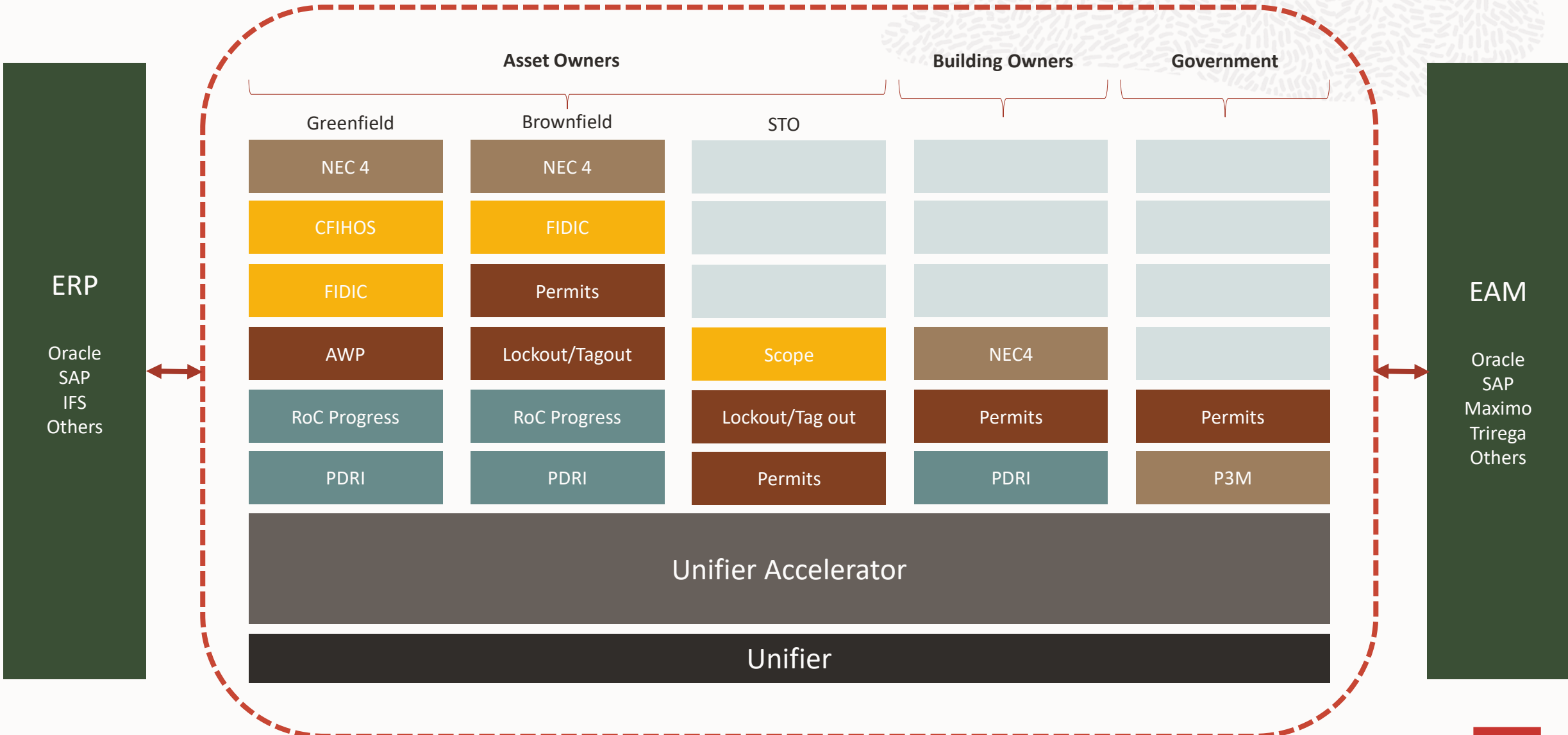

Unifier Essentials Base Template Content

Organizational Hierarchy

- Organization
- Region/District (Optional)
- Site/Campus (Optional)
- Building
- Project
- Program

Portfolio Management

- Project Requests

Libraries

- Standard Issues
- Areas
- Specification Sections
- Folder Templates
- Report Configuration

Funding and Budget Management

- Estimates
- Initial Budget
- Budget Change
- Budget Transfer
- Fund Appropriations
- Forecasts / Forecast Adjustments

Vendor Management

- Vendors

Contracts and Procurement

- Request for Bid
- Contracts
- Purchase Orders
- Master Service Agreements
- Work Releases
- Change Request
- Change Orders
- PO Amendments
- Payment Applications
- Invoices
- Journal Entries

Document Management and Submittals

- Submittal Packages
- Submittals
- Document Approval

Field Management

- Architect's Supplemental Instructions
- Daily Reports
- Field Observations
- Incident Management
- Requests for Information

Project Management

- Meeting Minutes
- Action Items
- Communications
- Risks
- Issues
- Project Notes
- Project Status

Closeout

- Lessons Learned
- Closeout Checklist
- Owner Walk Through
- Punchlist Items

Plus...

- User Defined Reports
- Custom Reports
- Custom Prints
- Portfolio Manager
- Schedule Manager
- Dashboards
- Document Manager
- Project Directory
- Cost Sheet
- Cash Flow / Forecasting
- Fund Sheet



Advanced Work Packaging - Model based Capital Project Delivery

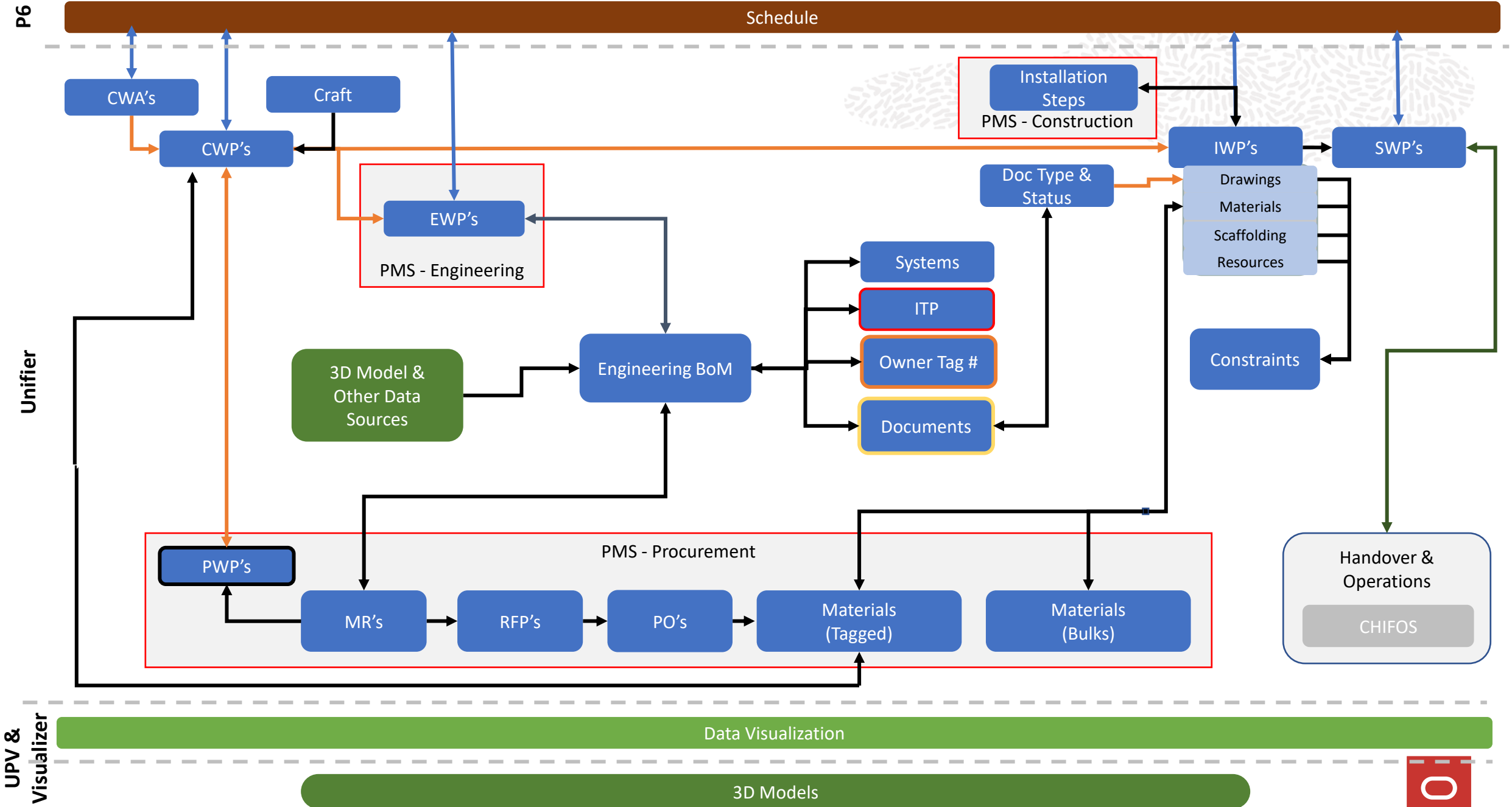

Project Driven Supply Chain for Construction

P6

Schedule

Unifier

ERP/SCM

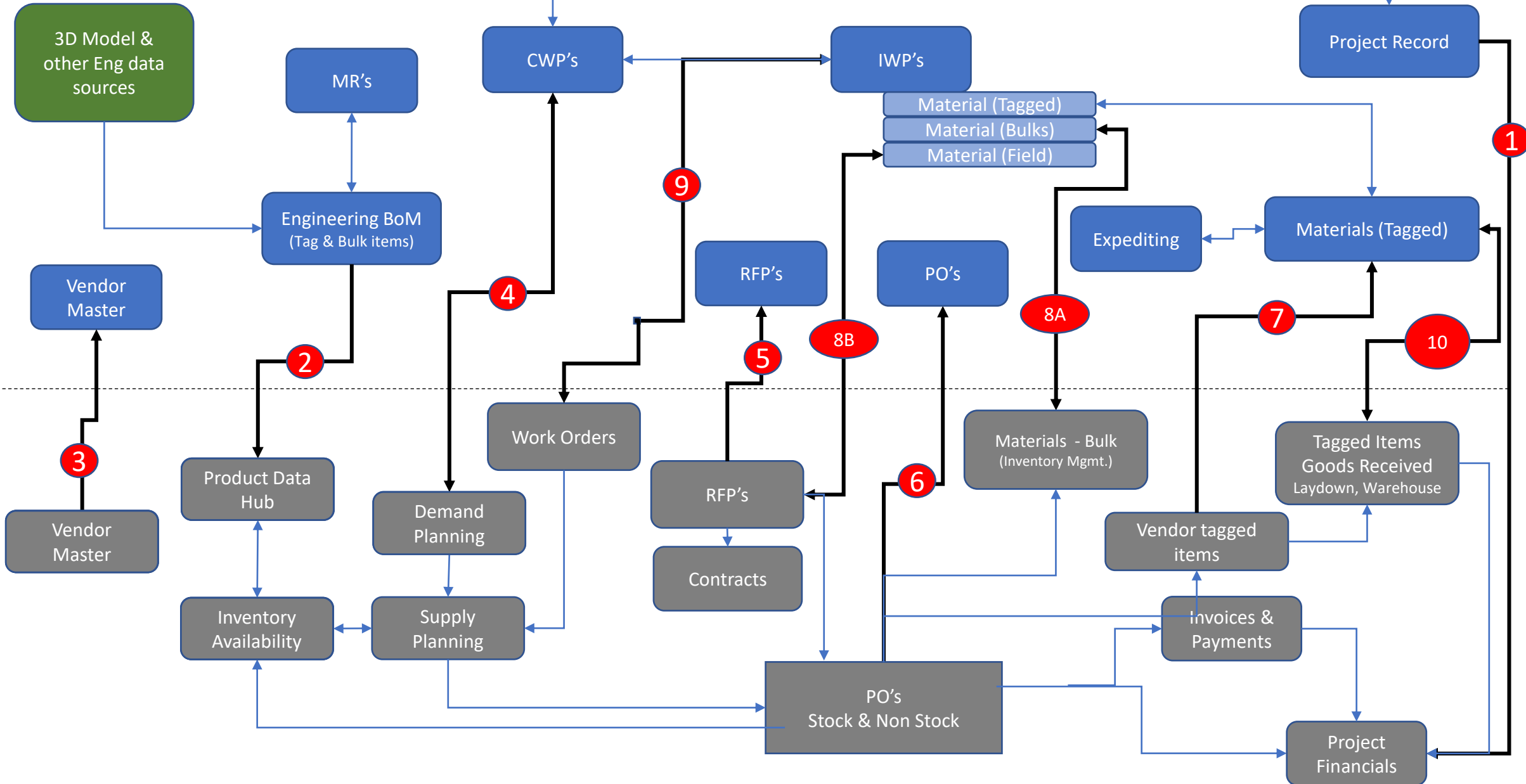

Safety - The next Step Change (Newmetrix)

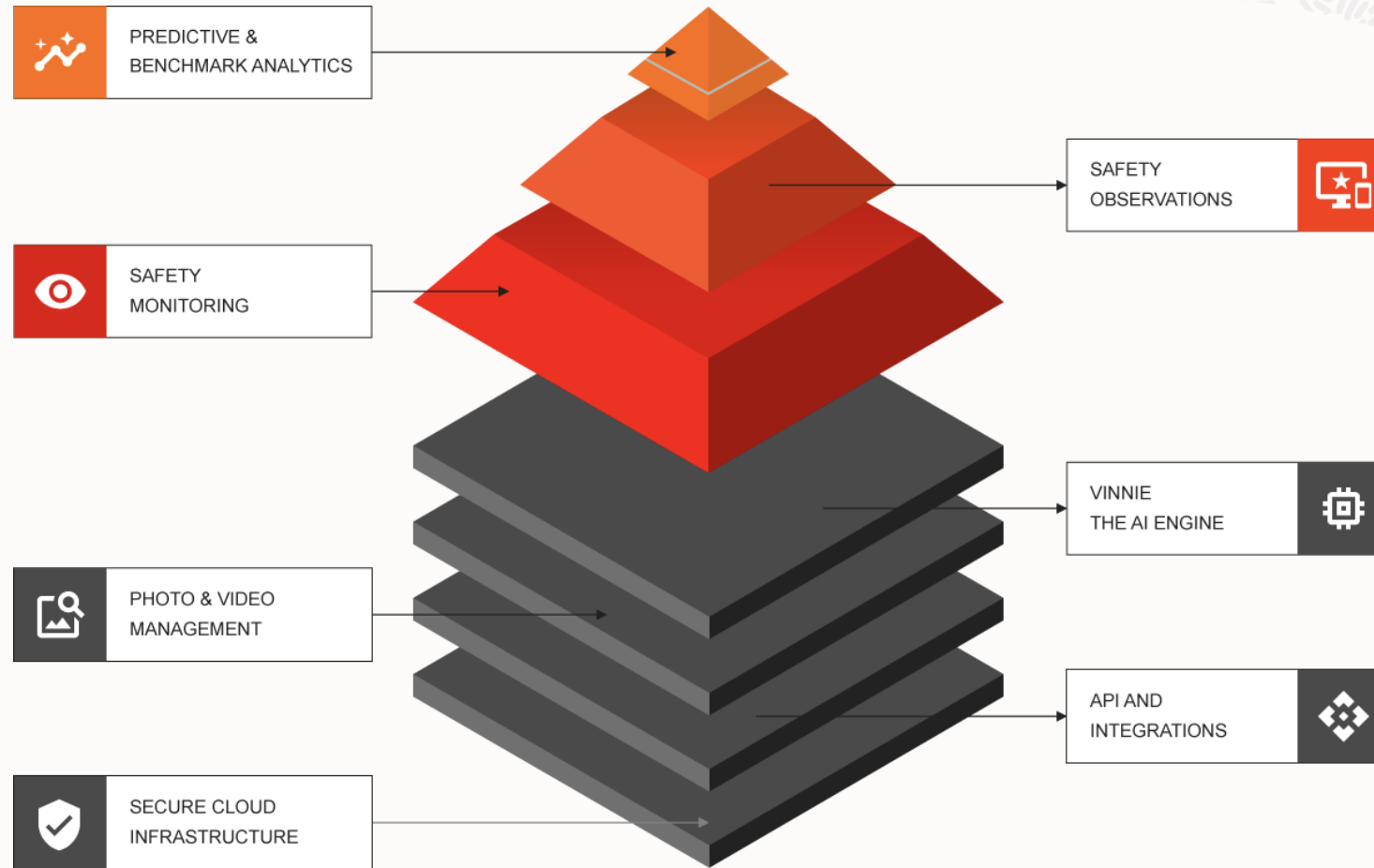

Proactive decision support

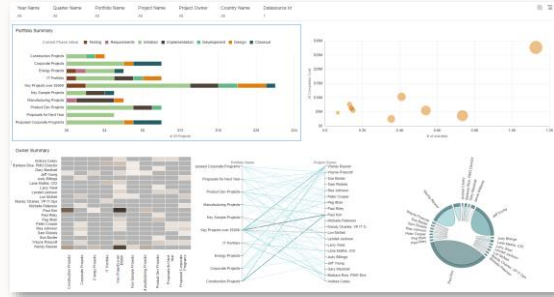

Portfolio Analysis

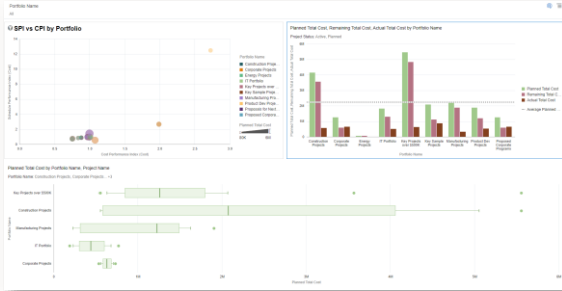

Identifying Outlier Projects

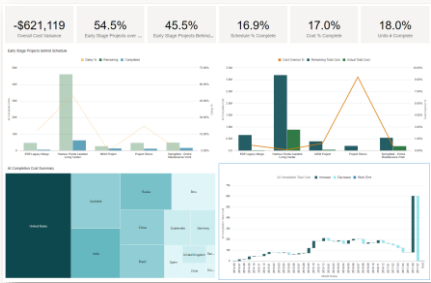

Schedule and Cost KPIs

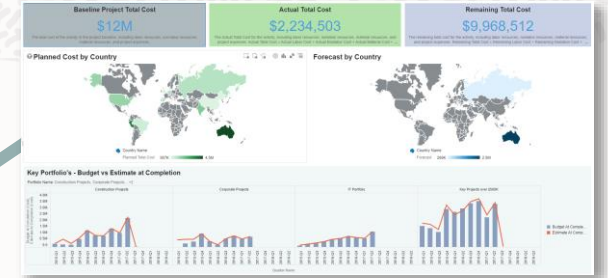
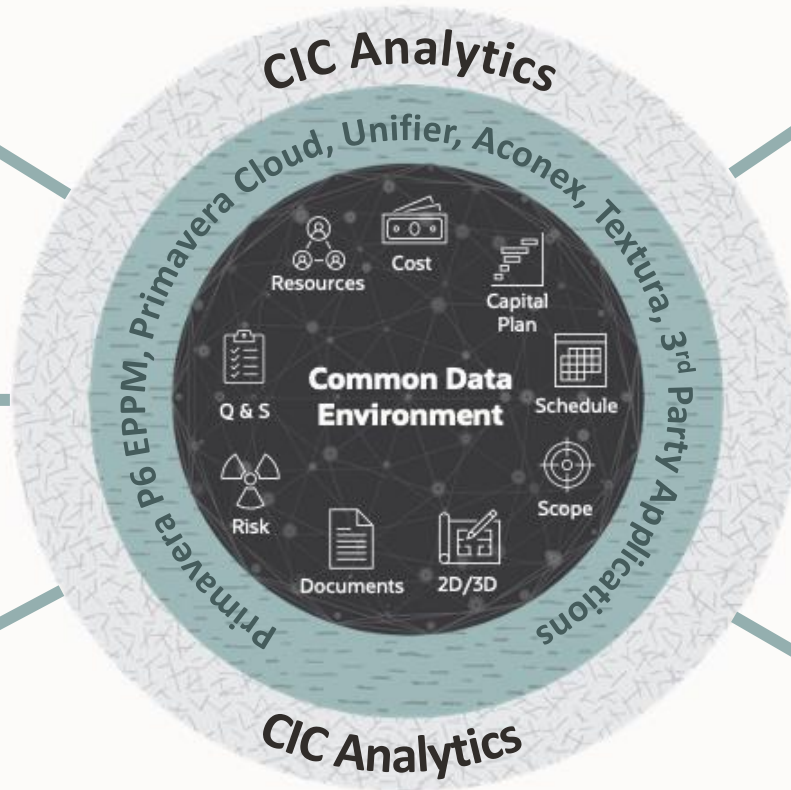

Cost KPIs

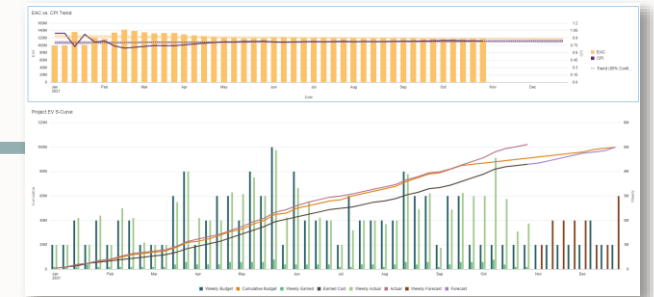

Tracking EV, EAC, and CPI Curves

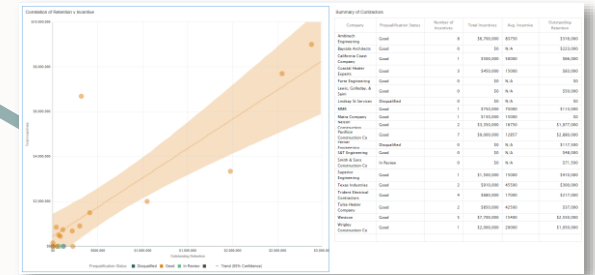

Contractor Financials



Oracle Industry Innovation Labs

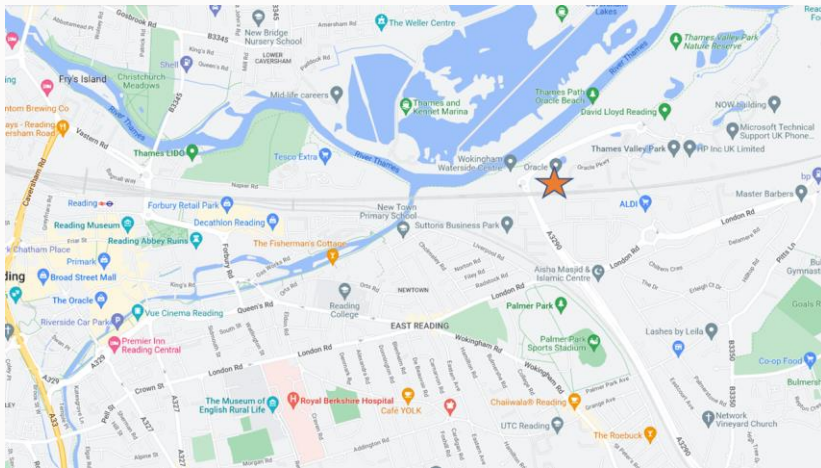
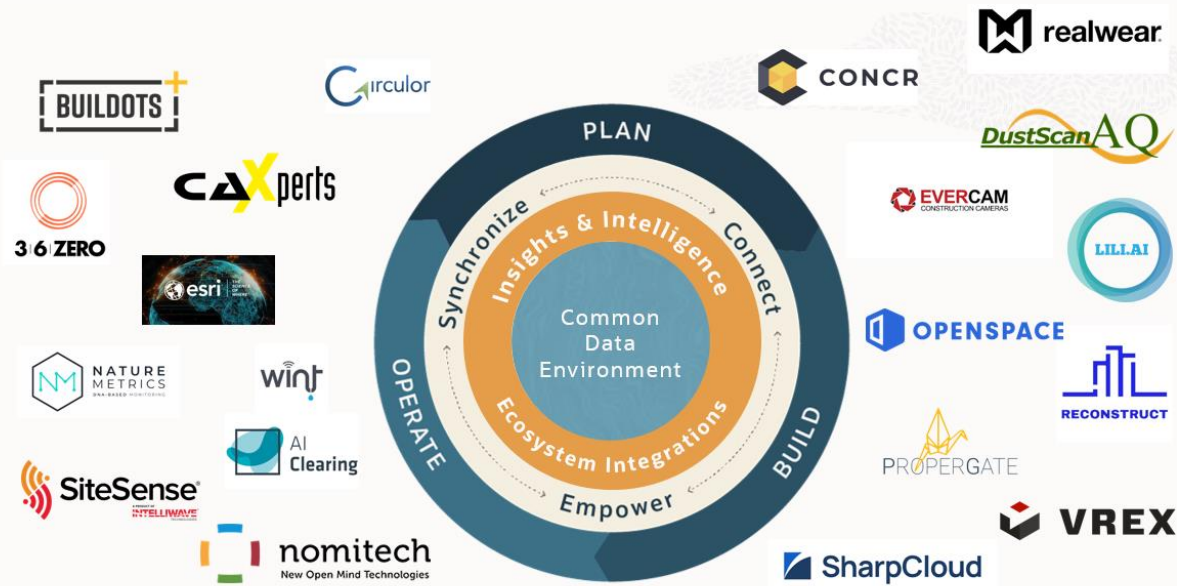

Oracle Industry Innovation lab
 Oracle Corporation
 Oracle Parkway
 Thames Valley Park
 Reading
 RG6 1RA

Innovation Lab Registration

London, UK

Reading, UK

Reading, UK
 Sustainability, Multimodal

Focus on transportation, linear construction, and sustainability, including 18 Innovation partners



Asset Data lifecycle story

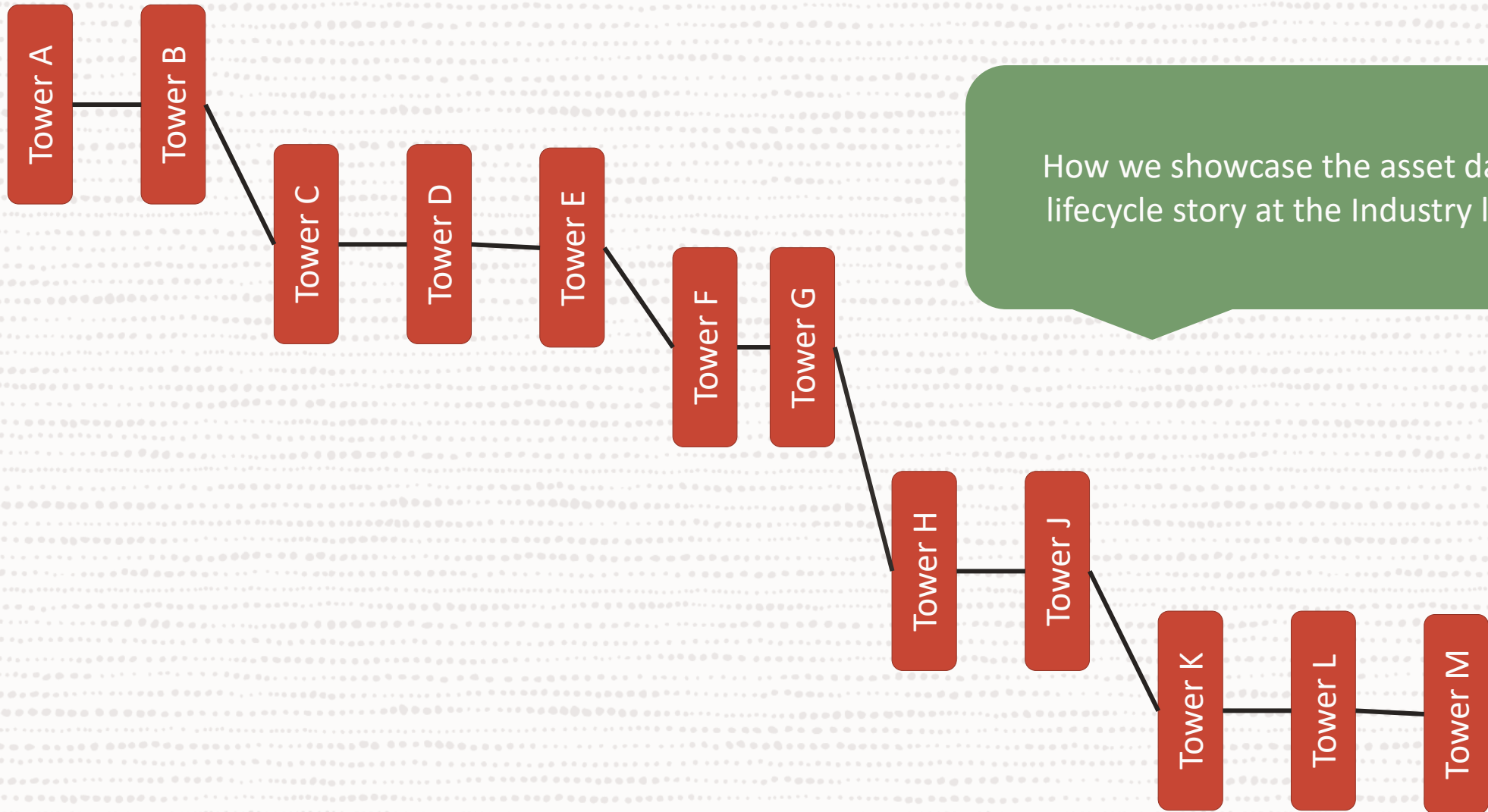

Front view
Scale: 1:20

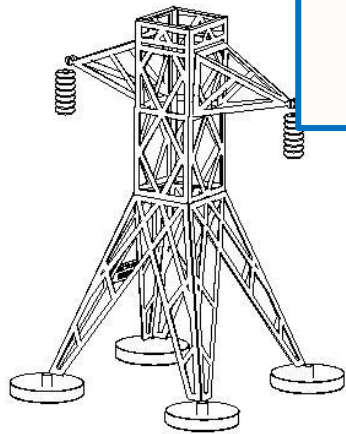
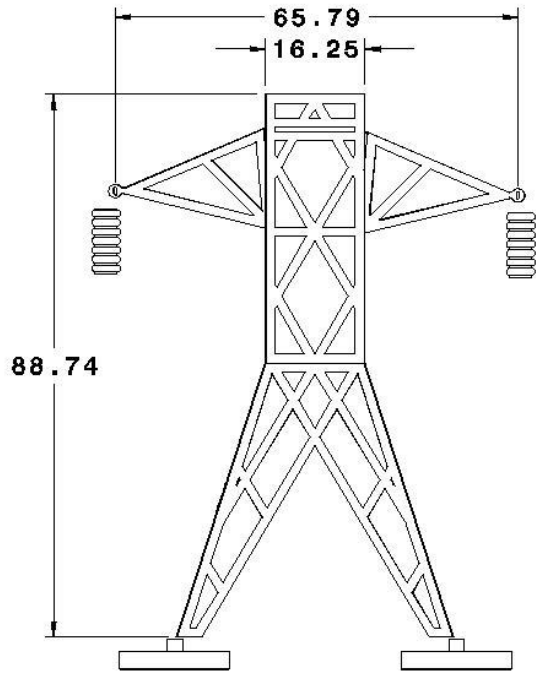

Isometric view
Scale: 1:30

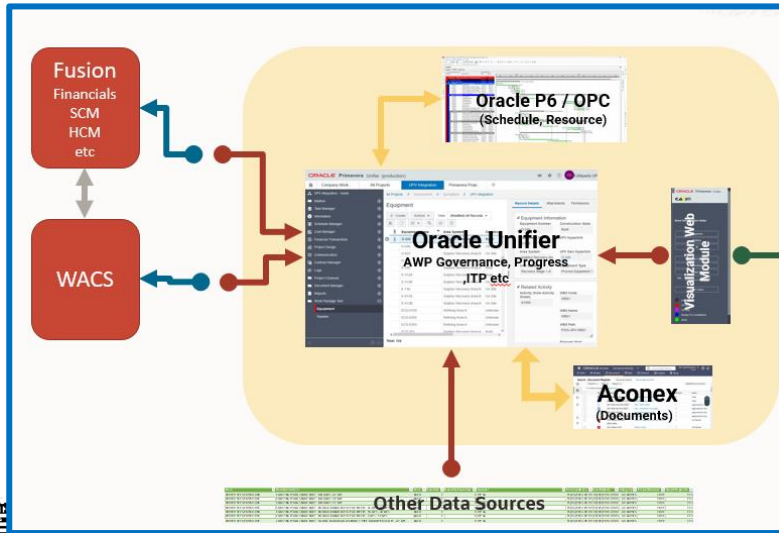
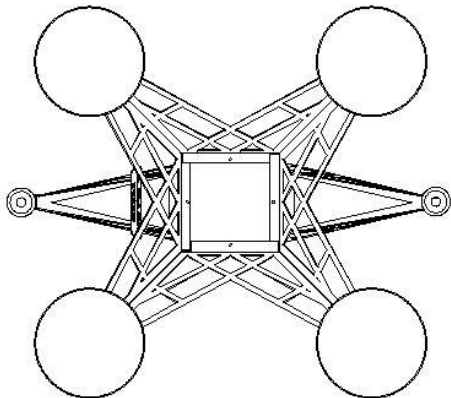

Demonstrate the asset data lifecycle story as a true business ecosystem

